

Data sheet | Item number: 2606-1103/020-000

PCB terminal block; lever; 6 mm<sup>2</sup>; Pin spacing 7.5 mm; 3-pole; Push-in CAGE CLAMP®

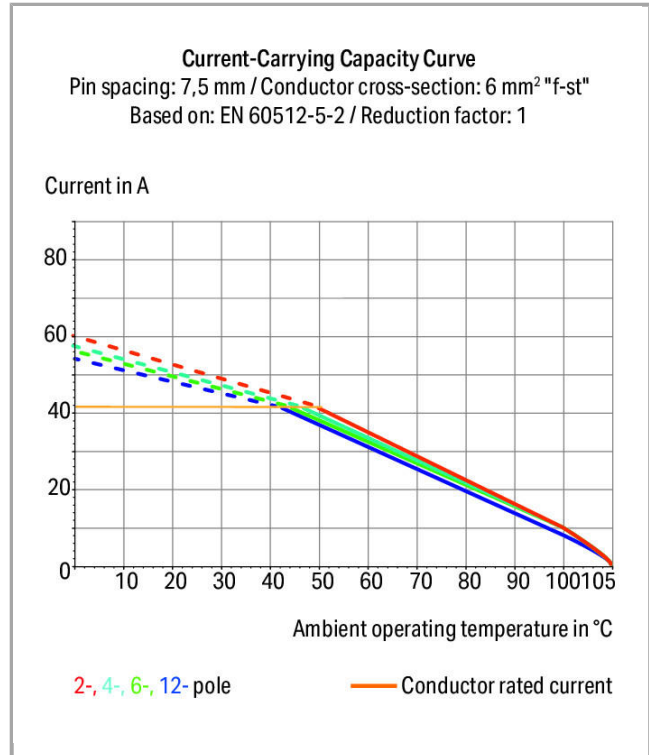

2606-1103/020-000



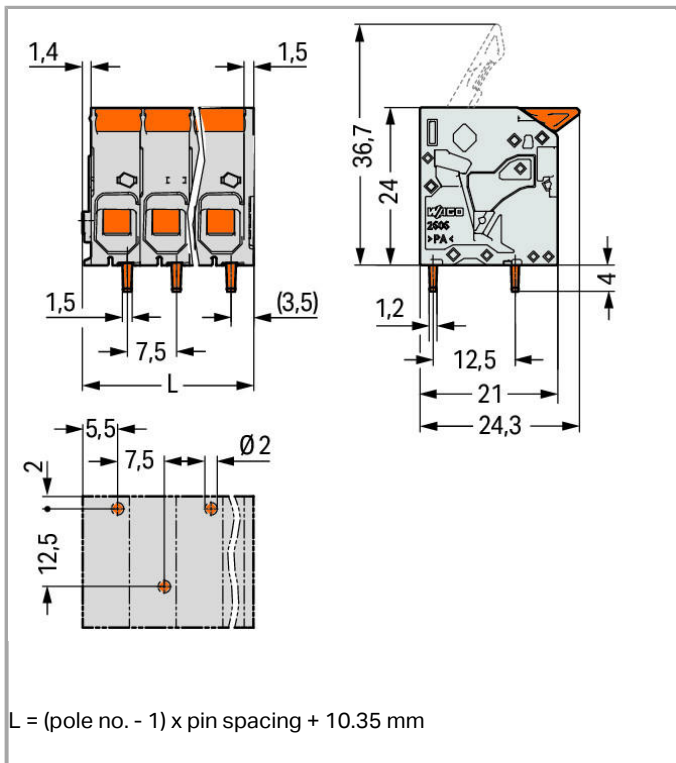

### Item description

- PCB terminal blocks with lever-actuated Push-in CAGE CLAMP® connection
- Push-in termination of solid and ferruled conductors
- Intuitive and tool-free operation
- Several clamping units can be held open simultaneously – convenient for terminating multi-core cables
- Testing can be performed both parallel and perpendicular to conductor entry

### Data

#### Electrical data

#### Ratings per IEC/EN 60664-1

Rated voltage (III / 3)	800 V
Rated impulse voltage (III / 3)	8 kV
Rated voltage (III / 2)	1000 V
Rated impulse voltage (III / 2)	8 kV
Rated voltage (II / 2)	1000 V
Rated impulse voltage (II / 2)	8 kV
Rated current	41 A

### Approvals per UL 1059

Rated voltage UL (Use Group B)	600 V
Rated current UL (Use Group B)	31 A
Rated voltage UL (Use Group C)	600 V
Rated current UL (Use Group C)	31 A

### Connection data

Connection technology	Push-in CAGE CLAMP®
Actuation type	Lever
Solid conductor	0.2 ... 10 mm <sup>2</sup> / 24 ... 8 AWG
Fine-stranded conductor	0.2 ... 10 mm <sup>2</sup> / 24 ... 8 AWG
Fine-stranded conductor with ferrule with plastic collar	0.25 ... 6 mm <sup>2</sup>
Fine-stranded conductor with ferrule without plastic collar	0.25 ... 6 mm <sup>2</sup>
Fine-stranded conductor, with twin ferrule	0.25 ... 2.5 mm <sup>2</sup>
Strip length	11 ... 13 mm / 0.43 ... 0.51 inch
Conductor entry angle to the PCB	0°
No. of poles	3
Total number of connection points	3
Total number of potentials	3
Number of connection types	1
Number of levels	1

### Geometrical Data

Pin spacing	7.5 mm / 0.295 inch
Width	25.35 mm / 0.998 inch
Height	28 mm / 1.102 inch
Height from the surface	24 mm / 0.945 inch
Depth	24.3 mm / 0.957 inch
Solder pin length	4 mm
Solder pin dimensions	1.5 x 1.2 mm
Drilled hole diameter (tolerance)	2 <sup>(- ... +0.1)</sup> mm

### PCB contact

PCB contact	THT
Solder pin arrangement	over the entire terminal strip, staggered
Number of solder pins per potential	1

## Material Data

Color	gray
Material group	I
Insulating material	Polyamide 66 (PA 66)
Flammability class per UL94	V0
Clamping spring material	Chrome nickel spring steel (CrNi)
Contact material	Electrolytic copper (E <sub>Cu</sub> )
Contact plating	tin-plated
Fire load	0MJ
Actuating element color	orange
Weight	11.748 g

## Environmental Requirements



Limit temperature range	-60 ... +105 °C
-------------------------	-----------------

## Commercial data

Country of origin	DE
GTIN	4055143586429
Customs Tariff No.	85369010000

## Approvals / Certificates

### Country specific Approvals







Logo	Approval	Additional Approval Text	Certificate name
	<b>CB</b> DEKRA Certification B.V.	IEC 60947-7-4	NL 49487 /M1
	<b>CSA</b> DEKRA Certification B.V.	C22.2 No. 158	70146882
	<b>KEMA/KEUR</b> DEKRA Certification B.V.	EN 60947-7-4	71- 103042

### UL-Approvals

Logo	Approval	Additional Approval Text	Certificate name
	<b>cULus</b> Underwriters Laboratories Inc.	UL 1059	E45172 Sec. 72

## Compatible products

### ferrule

	<b>Item no.: 216-108</b> Ferrule; Sleeve for 6 mm <sup>2</sup> / AWG 10; uninsulated; electro-tin plated	216-108
	<b>Item no.: 216-208</b> Ferrule; Sleeve for 6 mm <sup>2</sup> / AWG 10; insulated; electro-tin plated; electrolytic copper; gastight crimped; acc. to DIN 46228, Part 4/09.90	216-208
	<b>Item no.: 216-263</b> Ferrule; Sleeve for 1 mm <sup>2</sup> / AWG 18; insulated; electro-tin plated; electrolytic copper; gastight crimped; acc. to DIN 46228, Part 4/09.90	216-263
	<b>Item no.: 216-264</b> Ferrule; Sleeve for 1.5 mm <sup>2</sup> / AWG 16; insulated; electro-tin plated; electrolytic copper; gastight crimped; acc. to DIN 46228, Part 4/09.90	216-264
	<b>Item no.: 216-266</b> Ferrule; Sleeve for 2.5 mm <sup>2</sup> / AWG 14; insulated; electro-tin plated; electrolytic copper; gastight crimped; acc. to DIN 46228, Part 4/09.90	216-266
	<b>Item no.: 216-267</b> Ferrule; Sleeve for 4 mm <sup>2</sup> / AWG 12; insulated; electro-tin plated; electrolytic copper; gastight crimped; acc. to DIN 46228, Part 4/09.90	216-267

## Downloads

### Documentation

#### Additional Information

pdf  
3.6 MB

Download

## CAD/CAE - Smart Data

### CAD data

3D Download 2606-1103/020-000

URL

Download

Subject to changes.